

Dell™ Inspiron™ 1546 Service Manual

[Before You Begin](#)

[Battery](#)

[Hard Drive](#)

[Optical Drive](#)

[Module Cover](#)

[Memory Module\(s\)](#)

[Wireless Mini-Card](#)

[Processor Heat Sink](#)

[Processor Module](#)

[Center Control Cover](#)

[Keyboard](#)

[Internal Module With Bluetooth® Wireless Technology](#)

[Power Button Board](#)

[Display](#)

[Camera Module \(Optional\)](#)

[Palm Rest](#)

[Audio Connector Cover](#)

[Speakers](#)

[Daughter Board](#)

[System Board](#)

[Coin-Cell Battery](#)

[Thermal Fan](#)

[Battery Latch Assembly](#)

[Flashing the BIOS](#)

Notes, Cautions, and Warnings



NOTE: A NOTE indicates important information that helps you make better use of your computer.



CAUTION: A CAUTION indicates either potential damage to hardware or loss of data and tells you how to avoid the problem.



WARNING: A WARNING indicates a potential for property damage, personal injury, or death.

Information in this document is subject to change without notice.

© 2009 Dell Inc. All rights reserved.

Reproduction of these materials in any manner whatsoever without the written permission of Dell Inc. is strictly forbidden.

Trademarks used in this text: *Dell*, the *DELL* logo, and *Inspiron* are trademarks of Dell Inc.; *Bluetooth* is a registered trademark owned by Bluetooth SIG, Inc. and is used by Dell under license; *Microsoft*, *Windows*, *Windows Vista*, and *Windows Vista* start button logo are either trademarks or registered trademarks of Microsoft Corporation in the United States and/or other countries.

Other trademarks and trade names may be used in this document to refer to either the entities claiming the marks and names or their products. Dell Inc. disclaims any proprietary interest in trademarks and trade names other than its own.

Regulatory Model P02F Regulatory Type P02F001

November 2009 Rev. A00

Audio Connector Cover

Dell™ Inspiron™ 1546 Service Manual

- [Removing the Audio Connector Cover](#)
- [Replacing the Audio Connector Cover](#)

- ⚠ WARNING:** Before working inside your computer, read the safety information that shipped with your computer. For additional safety best practices information, see the Regulatory Compliance Homepage at www.dell.com/regulatory_compliance.
- ⚠ CAUTION:** Only a certified service technician should perform repairs on your computer. Damage due to servicing that is not authorized by Dell™ is not covered by your warranty.
- ⚠ CAUTION:** To avoid electrostatic discharge, ground yourself by using a wrist grounding strap or by periodically touching an unpainted metal surface (such as a connector on your computer).
- ⚠ CAUTION:** To help prevent damage to the system board, remove the main battery (see [Removing the Battery](#)) before working inside the computer.
-

Removing the Audio Connector Cover

1. Follow the procedures in [Before You Begin](#).
2. Remove the battery (see [Removing the Battery](#)).
3. Remove the module cover (see [Removing the Module Cover](#)).
4. Remove the memory module(s) (see [Removing the Memory Module\(s\)](#)).
5. Remove the hard drive (see [Removing the Hard Drive](#)).
6. Remove the Mini-Card (see [Removing the Mini-Card](#)).
7. Remove the center control cover (see [Removing the Center Control Cover](#)).
8. Remove the keyboard (see [Removing the Keyboard](#)).
9. Remove the Bluetooth module (see [Internal Module With Bluetooth® Wireless Technology](#)).
10. Remove the palm rest (see [Removing the Palm Rest](#)).
11. Lift the audio connector cover off the computer base.

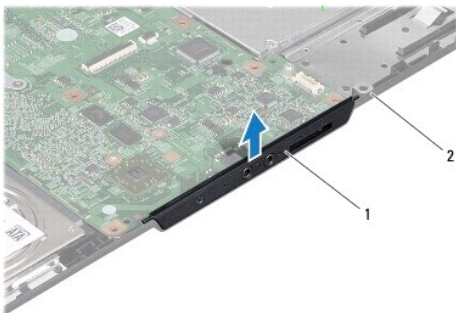

1	audio connector cover	2	computer base
---	-----------------------	---	---------------

Replacing the Audio Connector Cover

1. Follow the procedures in [Before You Begin](#).

2. Place the audio connector cover on the computer base.
3. Replace the palm rest (see [Replacing the Palm Rest](#)).
4. Replace the Bluetooth module (see [Internal Module With Bluetooth® Wireless Technology](#)).
5. Replace the keyboard (see [Replacing the Keyboard](#)).
6. Replace the center control cover (see [Replacing the Center Control Cover](#)).
7. Replace the Mini-Card (see [Replacing the Mini-Card](#)).
8. Replace the memory module(s) (see [Replacing the Memory Module\(s\)](#)).
9. Replace the module cover (see [Replacing the Module Cover](#)).
10. Replace the hard drive (see [Replacing the Hard Drive](#)).
11. Replace the battery (see [Replacing the Battery](#)).

 **CAUTION:** Before turning on the computer, replace all screws and ensure that no stray screws remain inside the computer. Failure to do so may result in damage to the computer.

[Back to Contents Page](#)

Module Cover

Dell™ Inspiron™ 1546 Service Manual

- [Removing the Module Cover](#)
- [Replacing the Module Cover](#)

- ⚠ WARNING:** Before working inside your computer, read the safety information that shipped with your computer. For additional safety best practices information, see the Regulatory Compliance Homepage at www.dell.com/regulatory_compliance.
- ⚠ CAUTION:** Only a certified service technician should perform repairs on your computer. Damage due to servicing that is not authorized by Dell™ is not covered by your warranty.
- ⚠ CAUTION:** To avoid electrostatic discharge, ground yourself by using a wrist grounding strap or by periodically touching an unpainted metal surface (such as a connector on your computer).
- ⚠ CAUTION:** To help prevent damage to the system board, remove the main battery (see [Removing the Battery](#)) before working inside the computer.
-

Removing the Module Cover

1. Follow the procedures in [Before You Begin](#).
2. Remove the battery (see [Removing the Battery](#)).
3. Loosen the four captive screws that secure the module cover to the computer base.
4. Lift the module cover off the computer at an angle as shown in the figure.

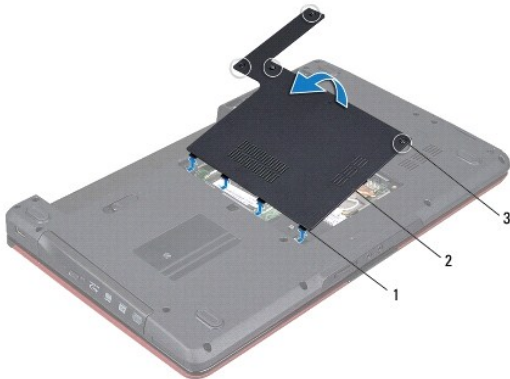

1	module cover tabs (4)	2	module cover
3	captive screws (4)		

Replacing the Module Cover

1. Follow the procedures in [Before You Begin](#).
2. Align the tabs on the module cover with the slots on the computer base and gently place it in position.
3. Tighten the four captive screws that secure the module cover to the computer base.
4. Replace the battery (see [Replacing the Battery](#)).

- ⚠ CAUTION:** Before turning on the computer, replace all screws and ensure that no stray screws remain inside the computer. Failure to do so may result in damage to the computer.
-

[Back to Contents Page](#)

Before You Begin

Dell™ Inspiron™ 1546 Service Manual

- [Recommended Tools](#)
- [Turning Off Your Computer](#)
- [Before Working Inside Your Computer](#)

This manual provides procedures for removing and installing components in your computer. Unless otherwise noted, each procedure assumes that the following conditions exist:

- 1 You have performed the steps in [Turning Off Your Computer](#) and [Before Working Inside Your Computer](#).
- 1 You have read the safety information that shipped with your computer.
- 1 A component can be replaced or—if purchased separately—installed by performing the removal procedure in the reverse order.

Recommended Tools

The procedures in this document may require the following tools:

- 1 Small flat-blade screwdriver
- 1 Phillips screwdriver
- 1 Plastic scribe
- 1 BIOS executable update program available at support.dell.com

Turning Off Your Computer

 **CAUTION:** To avoid losing data, save and close all open files and exit all open programs before you turn off your computer.

1. Save and close all open files and exit all open programs.
2. Shut down the operating system:

Windows Vista®:

Click **Start** , click the arrow , and then click **Shut Down**.

Windows 7:

Click **Start**  and then click **Shut Down**.

The computer turns off after the operating system shutdown process finishes.

3. Ensure that the computer and all attached devices are turned off. If your computer and attached devices did not automatically turn off when you shut down your operating system, press and hold the power button until the computer turns off.

Before Working Inside Your Computer

Use the following safety guidelines to help protect your computer from potential damage and to help to ensure your own personal safety.

 **WARNING:** Before working inside your computer, read the safety information that shipped with your computer. For additional safety best practices information, see the Regulatory Compliance Homepage at www.dell.com/regulatory_compliance.

 **CAUTION:** Only a certified service technician should perform repairs on your computer. Damage due to servicing that is not authorized by Dell is not covered by your warranty.

 **CAUTION:** To avoid electrostatic discharge, ground yourself by using a wrist grounding strap or by periodically touching an unpainted metal surface (such as a connector on your computer).

 **CAUTION:** Handle components and cards with care. Do not touch the components or contacts on a card. Hold a card by its edges or by its metal mounting bracket. Hold a component such as a processor by its edges, not by its pins.

△ **CAUTION:** When you disconnect a cable, pull on its connector or on its pull-tab, not on the cable itself. Some cables have connectors with locking tabs; if you are disconnecting this type of cable, press in on the locking tabs before you disconnect the cable. As you pull connectors apart, keep them evenly aligned to avoid bending any connector pins. Also, before you connect a cable, ensure that both connectors are correctly oriented and aligned.

△ **CAUTION:** To avoid damaging the computer, perform the following steps before you begin working inside the computer.

1. Ensure that the work surface is flat and clean to prevent the computer cover from being scratched.
2. Turn off your computer (see [Turning Off Your Computer](#)).
3. If the computer is connected to a docking device (docked), undock it. See the documentation that came with your docking device for instructions.

△ **CAUTION:** To disconnect a network cable, first unplug the cable from your computer and then unplug the cable from the network device.

4. Disconnect all telephone or network cables from the computer.
5. Press and eject any installed cards from the ExpressCard slot or the 7-in-1 Media Card Reader.
6. Disconnect your computer and all attached devices from their electrical outlets.

△ **CAUTION:** To help prevent damage to the system board, remove the main battery (see [Removing the Battery](#)) before working inside the computer.

7. Remove the battery (see [Removing the Battery](#)).
8. Turn the computer top-side up, open the display, and press the power button to ground the system board.

[Back to Contents Page](#)

Flashing the BIOS

Dell™ Inspiron™ 1546 Service Manual

1. Turn on the computer.
2. Go to support.dell.com.
3. Click **Drivers & Downloads**→ **Select Model**.
4. Locate the BIOS update file for your computer:

 **NOTE:** The Service Tag for your computer is located at the bottom of the computer.

If you have your computer's Service Tag:

- a. Click **Enter a Service Tag**.
- b. Enter your computer's Service Tag in the **Enter a service tag:** field, click **Go**, and proceed to step 5.

If you do not have your computer's Service Tag:

- a. Select the type of product in the **Select Your Product Family** list.
- b. Select the product brand in the **Select Your Product Line** list.
- c. Select the product model number in the **Select Your Product Model** list.

 **NOTE:** If you have selected a different model and want to start over again, click **Start Over** on the top right of the menu.

- d. Click **Confirm**.
5. A list of results appear on the screen. Click **BIOS**.
6. Click **Download Now** to download the latest BIOS file.
The **File Download** window appears.
7. Click **Save** to save the file on your desktop. The file downloads to your desktop.
8. Click **Close** if the **Download Complete** window appears.
The file icon appears on your desktop and is titled the same as the downloaded BIOS update file.
9. Double-click the file icon on the desktop and follow the procedures on the screen.

Internal Module With Bluetooth® Wireless Technology

Dell™ Inspiron™ 1546 Service Manual

- [Bluetooth Card](#)
- [Bluetooth Board](#)

- ⚠ WARNING:** Before working inside your computer, read the safety information that shipped with your computer. For additional safety best practices information, see the Regulatory Compliance Homepage at www.dell.com/regulatory_compliance.
- ⚠ CAUTION:** Only a certified service technician should perform repairs on your computer. Damage due to servicing that is not authorized by Dell™ is not covered by your warranty.
- ⚠ CAUTION:** To avoid electrostatic discharge, ground yourself by using a wrist grounding strap or by periodically touching an unpainted metal surface (such as a connector on your computer).
- ⚠ CAUTION:** To help prevent damage to the system board, remove the main battery (see [Removing the Battery](#)) before working inside the computer.

If you ordered a card with Bluetooth wireless technology with your computer, it is already installed.

Bluetooth Card

Removing the Bluetooth Card

1. Follow the procedures in [Before You Begin](#).
2. Remove the battery (see [Removing the Battery](#)).
3. Remove the module cover (see [Removing the Module Cover](#)).
4. Remove the memory module(s) (see [Removing the Memory Module\(s\)](#)).
5. Remove the hard drive (see [Removing the Hard Drive](#)).
6. Remove the center control cover (see [Removing the Center Control Cover](#)).
7. Remove the keyboard (see [Removing the Keyboard](#)).
8. Remove the screw that secures the Bluetooth card to the Bluetooth board.
9. Lift the Bluetooth card to disconnect it from the connector on the Bluetooth board.

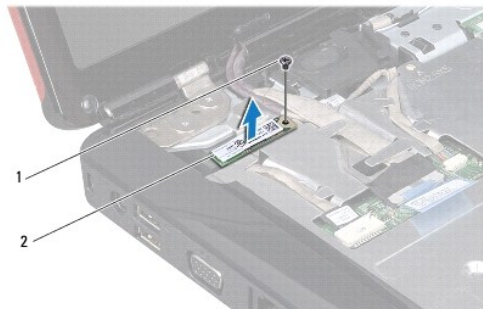

1	screw	2	Bluetooth card
---	-------	---	----------------

Replacing the Bluetooth Card

1. Follow the procedures in [Before You Begin](#).
2. Connect the Bluetooth card to the connector on the Bluetooth board.
3. Replace the screw that secures the Bluetooth card to the Bluetooth board.
4. Replace the keyboard (see [Replacing the Keyboard](#)).
5. Replace the center control cover (see [Replacing the Center Control Cover](#)).
6. Replace the hard drive (see [Replacing the Hard Drive](#)).
7. Replace the memory module(s) (see [Replacing the Memory Module\(s\)](#)).
8. Replace the module cover (see [Replacing the Module Cover](#)).
9. Replace the battery (see [Replacing the Battery](#)).

CAUTION: Before turning on the computer, replace all screws and ensure that no stray screws remain inside the computer. Failure to do so may result in damage to the computer.

Bluetooth Board

Removing the Bluetooth Board

1. Follow the procedures in [Before You Begin](#).
2. Remove the battery (see [Removing the Battery](#)).
3. Remove the module cover (see [Removing the Module Cover](#)).
4. Remove the memory module(s) (see [Removing the Memory Module\(s\)](#)).
5. Remove the hard drive (see [Removing the Hard Drive](#)).
6. Remove the center control cover (see [Removing the Center Control Cover](#)).
7. Remove the keyboard (see [Removing the Keyboard](#)).
8. Remove the Bluetooth card (see [Removing the Bluetooth Card](#)).
9. Disconnect the Bluetooth board cable from the system board connector and remove it from the routing guide.

CAUTION: The Bluetooth board is glued to the palm rest. Do not pull on the Bluetooth board cable to remove the Bluetooth board.

10. Using a plastic scribe, pry out the Bluetooth board to release it from the palm rest.

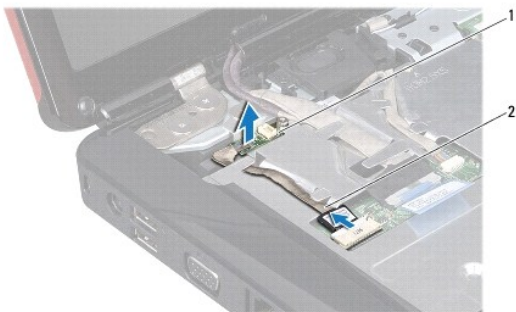

Replacing the Bluetooth Board

1. Follow the procedures in [Before You Begin](#).
2. Align the Bluetooth board with the slot on the palm rest and adhere the Bluetooth board on the palm rest.
3. Route the Bluetooth board cable through the routing guide and connect it to the system board connector.
4. Replace the Bluetooth card (see [Replacing the Bluetooth Card](#)).
5. Replace the keyboard (see [Replacing the Keyboard](#)).
6. Replace the center control cover (see [Replacing the Center Control Cover](#)).
7. Replace the hard drive (see [Replacing the Hard Drive](#)).
8. Replace the memory module(s) (see [Replacing the Memory Module\(s\)](#)).
9. Replace the module cover (see [Replacing the Module Cover](#)).
10. Replace the battery (see [Replacing the Battery](#)).

 **CAUTION:** Before turning on the computer, replace all screws and ensure that no stray screws remain inside the computer. Failure to do so may result in damage to the computer.

[Back to Contents Page](#)

Camera Module (Optional)

Dell™ Inspiron™ 1546 Service Manual

- [Removing the Camera Module](#)
- [Replacing the Camera Module](#)

- ⚠ WARNING:** Before working inside your computer, read the safety information that shipped with your computer. For additional safety best practices information, see the Regulatory Compliance Homepage at www.dell.com/regulatory_compliance.
- ⚠ CAUTION:** Only a certified service technician should perform repairs on your computer. Damage due to servicing that is not authorized by Dell™ is not covered by your warranty.
- ⚠ CAUTION:** To avoid electrostatic discharge, ground yourself by using a wrist grounding strap or by periodically touching an unpainted metal surface (such as a connector on your computer).
- ⚠ CAUTION:** To help prevent damage to the system board, remove the main battery (see [Removing the Battery](#)) before working inside the computer.
-

Removing the Camera Module

1. Follow the procedures in [Before You Begin](#).
2. Remove the display assembly (see [Removing the Display Assembly](#)).
3. Remove the display bezel (see [Removing the Display Bezel](#)).
4. Remove the display panel (see [Removing the Display Panel](#)).
5. Disconnect the camera cable from the connector on the camera module.
6. Remove the two screws that secure the camera module to the display cover.
7. Remove the camera module.

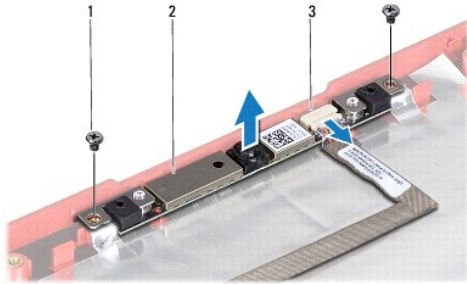

1	screws (2)	2	camera module
3	camera cable connector		

Replacing the Camera Module

1. Follow the procedures in [Before You Begin](#).
2. Replace the two screws that secure the camera module to the display cover.
3. Connect the camera cable to the connector on the camera module.
4. Replace the display panel (see [Replacing the Display Panel](#)).

5. Replace the display bezel (see [Replacing the Display Bezel](#)).
6. Replace the display assembly (see [Replacing the Display Assembly](#)).

 **CAUTION:** Before turning on the computer, replace all screws and ensure that no stray screws remain inside the computer. Failure to do so may result in damage to the computer.

[Back to Contents Page](#)

[Back to Contents Page](#)

Center Control Cover

Dell™ Inspiron™ 1546 Service Manual

- [Removing the Center Control Cover](#)
- [Replacing the Center Control Cover](#)

- ⚠ WARNING:** Before working inside your computer, read the safety information that shipped with your computer. For additional safety best practices information, see the Regulatory Compliance Homepage at www.dell.com/regulatory_compliance.
- ⚠ CAUTION:** Only a certified service technician should perform repairs on your computer. Damage due to servicing that is not authorized by Dell™ is not covered by your warranty.
- ⚠ CAUTION:** To avoid electrostatic discharge, ground yourself by using a wrist grounding strap or by periodically touching an unpainted metal surface (such as a connector on your computer).
- ⚠ CAUTION:** To help prevent damage to the system board, remove the main battery (see [Removing the Battery](#)) before working inside the computer.
-

Removing the Center Control Cover

1. Follow the procedures in [Before You Begin](#).
2. Remove the battery (see [Removing the Battery](#)).
3. Remove the two screws that secure the center control cover to the computer base.

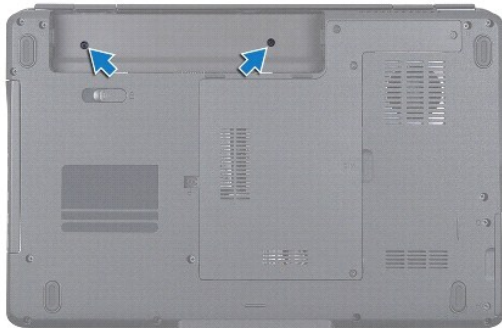

4. Turn the computer top side up, and open the display as far as possible.
- ⚠ CAUTION:** Be extremely careful when removing the center control cover. The cover is very fragile.
5. Pry out the center control cover with a plastic scribe.
 6. Ease the center control cover up.



1	center control cover
---	----------------------

Replacing the Center Control Cover

1. Follow the procedures in [Before You Begin](#).
2. Align the tabs on the center control cover with the slots on the palm rest and snap the cover in place.
3. Replace the two screws that secure the center control cover to the computer base.
4. Replace the battery (see [Replacing the Battery](#)).

CAUTION: Before turning on the computer, replace all screws and ensure that no stray screws remain inside the computer. Failure to do so may result in damage to the computer.

[Back to Contents Page](#)

Coin-Cell Battery

Dell™ Inspiron™ 1546 Service Manual

- [Removing the Coin-Cell Battery](#)
- [Replacing the Coin-Cell Battery](#)

- ⚠ WARNING:** Before working inside your computer, read the safety information that shipped with your computer. For additional safety best practices information, see the Regulatory Compliance Homepage at www.dell.com/regulatory_compliance.
- ⚠ CAUTION:** Only a certified service technician should perform repairs on your computer. Damage due to servicing that is not authorized by Dell™ is not covered by your warranty.
- ⚠ CAUTION:** To avoid electrostatic discharge, ground yourself by using a wrist grounding strap or by periodically touching an unpainted metal surface (such as a connector on your computer).
- ⚠ CAUTION:** To help prevent damage to the system board, remove the main battery (see [Removing the Battery](#)) before working inside the computer.
-

Removing the Coin-Cell Battery

1. Follow the procedures in [Before You Begin](#).
2. Remove the system board (see [Removing the System Board](#)).
3. Turn the system board over.
4. Use a plastic scribe to pry out the coin-cell battery.

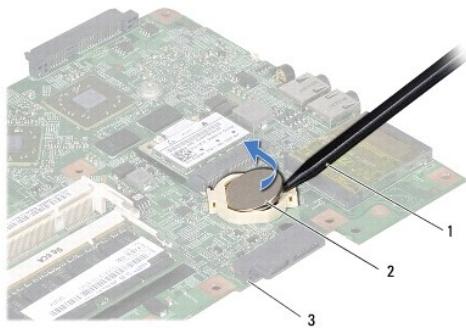

1	plastic scribe	2	coin-cell battery
3	system board		

Replacing the Coin-Cell Battery

1. Follow the procedures in [Before You Begin](#).
2. Hold the coin-cell battery with the positive (+) side facing up.
3. Slide the coin-cell battery into the slot on the system board and gently press until it snaps into place.
4. Replace the system board (see [Replacing the System Board](#)).

- ⚠ CAUTION:** Before turning on the computer, replace all screws and ensure that no stray screws remain inside the computer. Failure to do so may result in damage to the computer.
-

Processor Module

Dell™ Inspiron™ 1546 Service Manual

- [Removing the Processor Module](#)
- [Replacing the Processor Module](#)

- ⚠ WARNING:** Before working inside your computer, read the safety information that shipped with your computer. For additional safety best practices information, see the Regulatory Compliance Homepage at www.dell.com/regulatory_compliance.
- ⚠ CAUTION:** Only a certified service technician should perform repairs on your computer. Damage due to servicing that is not authorized by Dell™ is not covered by your warranty.
- ⚠ CAUTION:** To avoid electrostatic discharge, ground yourself by using a wrist grounding strap or by periodically touching an unpainted metal surface (such as a connector on your computer).
- ⚠ CAUTION:** To prevent intermittent contact between the ZIF-socket cam screw and the processor when removing or replacing the processor, press to apply slight pressure to the center of the processor while turning the cam screw.
- ⚠ CAUTION:** To avoid damage to the processor, hold the screwdriver so that it is perpendicular to the processor when turning the cam screw.
- ⚠ CAUTION:** To help prevent damage to the system board, remove the main battery (see [Removing the Battery](#)) before working inside the computer.
-

Removing the Processor Module

1. Follow the procedures in [Before You Begin](#).
2. Remove the battery (see [Removing the Battery](#)).
3. Remove the module cover (see [Removing the Module Cover](#)).
4. Remove the memory module(s) (see [Removing the Memory Module\(s\)](#)).
5. Remove the Mini-Card (see [Removing the Mini-Card](#)).
6. Remove the processor heat sink (see [Removing the Processor Heat Sink](#)).
7. To loosen the ZIF socket, use a small flat-blade screwdriver and rotate the ZIF-socket cam screw counterclockwise until it comes to the cam stop.

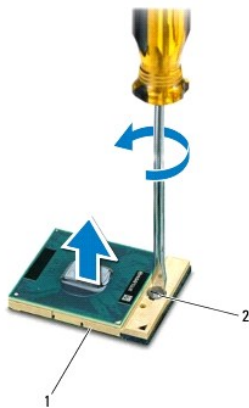

1	ZIF socket	2	ZIF-socket cam screw
---	------------	---	----------------------

- ⚠ CAUTION:** To ensure maximum cooling for the processor, do not touch the heat transfer areas on the processor thermal-cooling assembly. The oils in your skin can reduce the heat transfer capability of the thermal pads.

 **CAUTION:** When removing the processor module, lift the module straight up. Be careful not to bend the pins on the processor module.

8. Lift the processor module from the ZIF socket.
-

Replacing the Processor Module

 **NOTE:** If a new processor is installed, you will receive a new thermal-cooling assembly, which will include an affixed thermal pad, or you will receive a new thermal pad along with documentation to illustrate proper installation.

1. Follow the procedures in [Before You Begin](#).
2. Align the pin-1 corner of the processor module with the pin-1 corner of the ZIF socket, then place the processor module.

 **NOTE:** The pin-1 corner of the processor module has a triangle that aligns with the triangle on the pin-1 corner of the ZIF socket.

When the processor module is properly seated, all four corners are aligned at the same height. If one or more corners of the module are higher than the others, the module is not seated properly.

 **CAUTION:** To avoid damage to the processor, hold the screwdriver perpendicular to the processor when turning the cam screw.

3. Tighten the ZIF socket by turning the cam screw clockwise to secure the processor module to the system board.
4. Replace the processor heat sink (see [Replacing the Processor Heat Sink](#)).
5. Replace the Mini-Card (see [Replacing the Mini-Card](#)).
6. Replace the memory module(s) (see [Replacing the Memory Module\(s\)](#)).
7. Replace the module cover (see [Replacing the Module Cover](#)).
8. Replace the battery (see [Replacing the Battery](#)).

 **CAUTION:** Before turning on the computer, replace all screws and ensure that no stray screws remain inside the computer. Failure to do so may result in damage to the computer.

[Back to Contents Page](#)

Processor Heat Sink

Dell™ Inspiron™ 1546 Service Manual

- [Removing the Processor Heat Sink](#)
- [Replacing the Processor Heat Sink](#)

- ⚠ WARNING:** Before working inside your computer, read the safety information that shipped with your computer. For additional safety best practices information, see the Regulatory Compliance Homepage at www.dell.com/regulatory_compliance.
- ⚠ WARNING:** If you remove the processor heat sink from the computer when the heat sink is hot, do not touch the metal housing of the processor heat sink.
- ⚠ CAUTION:** Only a certified service technician should perform repairs on your computer. Damage due to servicing that is not authorized by Dell™ is not covered by your warranty.
- ⚠ CAUTION:** To avoid electrostatic discharge, ground yourself by using a wrist grounding strap or by periodically touching an unpainted metal surface (such as a connector on your computer).
- ⚠ CAUTION:** To help prevent damage to the system board, remove the main battery (see [Removing the Battery](#)) before working inside the computer.
-

Removing the Processor Heat Sink

1. Follow the procedures in [Before You Begin](#).
2. Remove the battery (see [Removing the Battery](#)).
3. Remove the module cover (see [Removing the Module Cover](#)).
4. Remove the memory module(s) (see [Removing the Memory Module\(s\)](#)).
5. Remove the Mini-Card (see [Removing the Mini-Card](#)).
6. In sequential order (indicated on the processor heat sink) loosen the five captive screws that secure the processor heat sink to the system board.
7. Pry out the processor heat sink with a plastic scribe.
8. Lift the processor heat sink off the computer base.

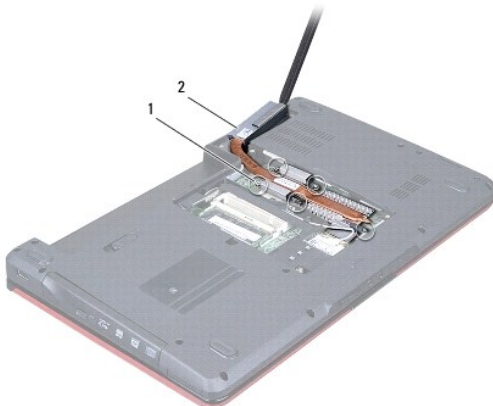

1	captive screws (5)	2	processor heat sink
---	--------------------	---	---------------------

Replacing the Processor Heat Sink

 **NOTE:** The original thermal pad can be reused if the original processor and heat sink are reinstalled together. If either the processor or heat sink is replaced, use the thermal pad provided in the kit to ensure that thermal conductivity is achieved.

 **NOTE:** This procedure assumes that you have already removed the processor heat sink and are ready to replace it.

1. Follow the procedures in [Before You Begin](#).
2. Align the five captive screws on the processor heat sink with the screw holes on the system board and tighten the screws in sequential order (indicated on the processor heat sink).
3. Replace the Mini-Card (see [Replacing the Mini-Card](#)).
4. Replace the memory module(s) (see [Replacing the Memory Module\(s\)](#)).
5. Replace the module cover (see [Replacing the Module Cover](#)).
6. Replace the battery (see [Replacing the Battery](#)).

 **CAUTION:** Before turning on the computer, replace all screws and ensure that no stray screws remain inside the computer. Failure to do so may result in damage to the computer.

[Back to Contents Page](#)

Daughter Board

Dell™ Inspiron™ 1546 Service Manual

- [Removing the Daughter Board](#)
- [Replacing the Daughter Board](#)

- ⚠ WARNING:** Before working inside your computer, read the safety information that shipped with your computer. For additional safety best practices information, see the Regulatory Compliance Homepage at www.dell.com/regulatory_compliance.
- ⚠ CAUTION:** Only a certified service technician should perform repairs on your computer. Damage due to servicing that is not authorized by Dell™ is not covered by your warranty.
- ⚠ CAUTION:** To avoid electrostatic discharge, ground yourself by using a wrist grounding strap or by periodically touching an unpainted metal surface (such as a connector on your computer).
- ⚠ CAUTION:** To help prevent damage to the system board, remove the main battery (see [Removing the Battery](#)) before working inside the computer.
-

Removing the Daughter Board

1. Follow the procedures in [Before You Begin](#).
2. Remove the battery (see [Removing the Battery](#)).
3. Remove the module cover (see [Removing the Module Cover](#)).
4. Remove the memory module(s) (see [Removing the Memory Module\(s\)](#)).
5. Remove the hard drive (see [Removing the Hard Drive](#)).
6. Remove the Mini-Card (see [Removing the Mini-Card](#)).
7. Remove the center control cover (see [Removing the Center Control Cover](#)).
8. Remove the keyboard (see [Removing the Keyboard](#)).
9. Remove the Bluetooth module (see [Internal Module With Bluetooth® Wireless Technology](#)).
10. Remove the palm rest (see [Removing the Palm Rest](#)).
11. Remove the three screws that secure the daughter board to the computer base.
12. Lift the daughter board off the computer base.

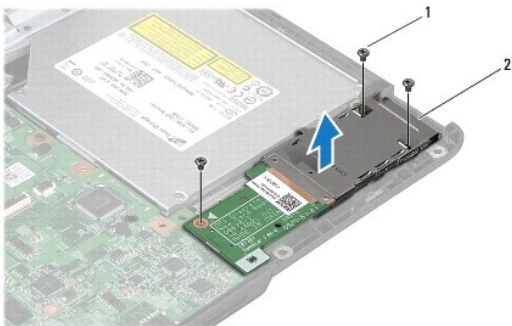

1	screws (3)	2	daughter board
---	------------	---	----------------

Replacing the Daughter Board

1. Follow the procedures in [Before You Begin](#).
2. Align the screw holes on the daughter board with the screw holes on the computer base.
3. Replace the three screws that secure the daughter board to the computer base.
4. Replace the palm rest (see [Replacing the Palm Rest](#)).
5. Replace the Bluetooth module (see [Internal Module With Bluetooth® Wireless Technology](#)).
6. Replace the keyboard (see [Replacing the Keyboard](#)).
7. Replace the center control cover (see [Replacing the Center Control Cover](#)).
8. Replace the Mini-Card (see [Replacing the Mini-Card](#)).
9. Replace the memory module(s) (see [Replacing the Memory Module\(s\)](#)).
10. Replace the module cover (see [Replacing the Module Cover](#)).
11. Replace the hard drive (see [Replacing the Hard Drive](#)).
12. Replace the battery (see [Replacing the Battery](#)).

 **CAUTION:** Before turning on the computer, replace all screws and ensure that no stray screws remain inside the computer. Failure to do so may result in damage to the computer.

[Back to Contents Page](#)

[Back to Contents Page](#)

Display

Dell™ Inspiron™ 1546 Service Manual

- [Display Assembly](#)
- [Display Bezel](#)
- [Display Panel](#)
- [Display Panel Cable](#)
- [Display Hinges](#)

- WARNING:** Before working inside your computer, read the safety information that shipped with your computer. For additional safety best practices information, see the Regulatory Compliance Homepage at www.dell.com/regulatory_compliance.
- CAUTION:** Only a certified service technician should perform repairs on your computer. Damage due to servicing that is not authorized by Dell™ is not covered by your warranty.
- CAUTION:** To avoid electrostatic discharge, ground yourself by using a wrist grounding strap or by periodically touching an unpainted metal surface (such as a connector on your computer).
- CAUTION:** To help prevent damage to the system board, remove the main battery (see [Removing the Battery](#)) before working inside the computer.
-

Display Assembly

Removing the Display Assembly

1. Follow the procedures in [Before You Begin](#).
2. Remove the battery (see [Removing the Battery](#)).
3. Remove the module cover (see [Removing the Module Cover](#)).
4. Remove the memory module(s) (see [Removing the Memory Module\(s\)](#)).
5. Remove the hard drive (see [Removing the Hard Drive](#)).
6. Remove the Mini-Card (see [Removing the Mini-Card](#)).
7. Make note of the Mini-Card antenna cables routing and remove the cables from the routing guides.

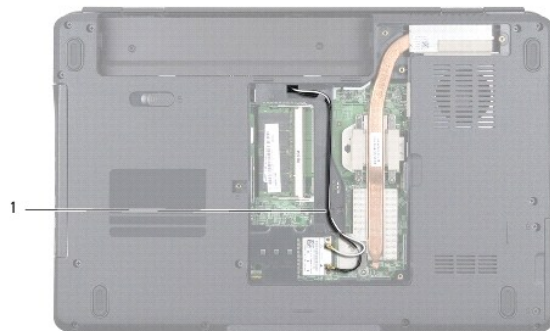

1	Mini-Card cable routing
---	-------------------------

8. Remove the two screws from the computer base.

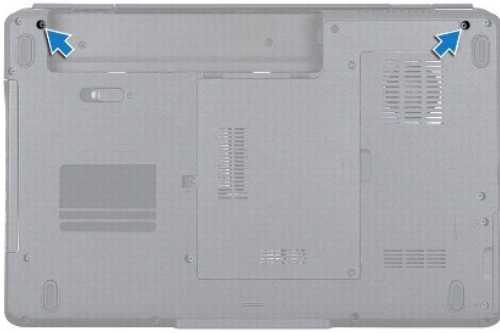

9. Remove the center control cover (see [Removing the Center Control Cover](#)).
10. Remove the keyboard (see [Removing the Keyboard](#)).
11. Make note of the Mini-Card antenna cable routing and carefully dislodge the antenna cables from the cable routing slot on the computer. Pull the cables away, so that they are clear of the palm rest.

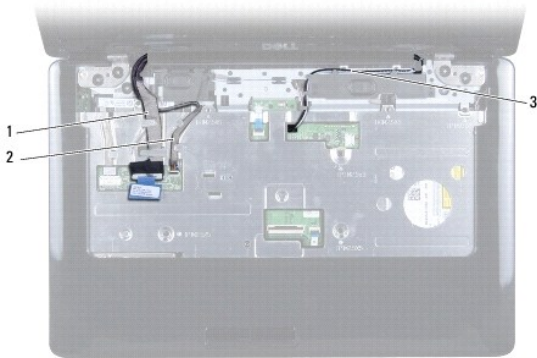

1	display cable routing	2	camera cable routing
3	Mini-Card cable routing		

12. Disconnect the display cable and camera cable from the respective system board connectors and remove them from their routing guides.
13. Remove the four screws that secure the display assembly to the computer base.
14. Lift and remove the display assembly from the computer base.

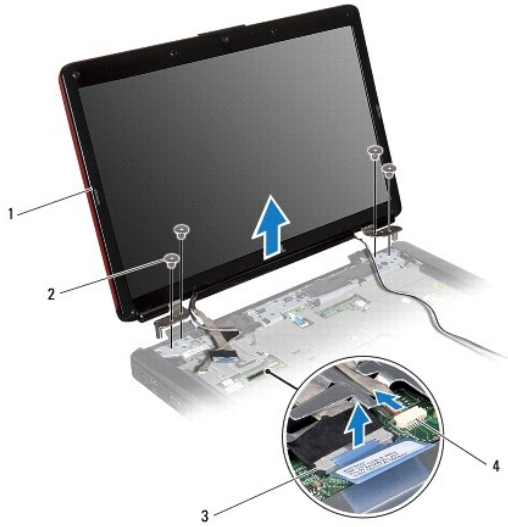

1	display assembly	2	screws (4)
3	display cable connector	4	camera cable connector

Replacing the Display Assembly

1. Follow the procedures in [Before You Begin](#).
2. Place the display assembly in position and replace the four screws that secure the display assembly to the computer base.
3. Route the display cable and camera cable into their routing guides and connect the cables to the respective system board connectors.
4. Route the Mini-Card antenna cables, and guide the cables to the bottom of the computer through the cable routing slot.
5. Replace the keyboard (see [Replacing the Keyboard](#)).
6. Replace the center control cover (see [Replacing the Center Control Cover](#)).
7. Replace the two screws at the bottom of the computer.
8. Route the Mini-Card antenna cables through the routing guides at the bottom of the computer, and replace the Mini-Card (see [Replacing the Mini-Card](#)).
9. Replace the hard drive (see [Replacing the Hard Drive](#)).
10. Replace the memory module(s) (see [Replacing the Memory Module\(s\)](#)).
11. Replace the module cover (see [Replacing the Module Cover](#)).
12. Replace the battery (see [Replacing the Battery](#)).

CAUTION: Before turning on the computer, replace all screws and ensure that no stray screws remain inside the computer. Failure to do so may result in damage to the computer.

Display Bezel

Removing the Display Bezel

CAUTION: The display bezel is extremely fragile. Be careful when removing it to prevent damaging the bezel.

1. Follow the procedures in [Before You Begin](#).
2. Remove the display assembly (see [Removing the Display Assembly](#)).
3. Remove the six rubber pads that cover the screws securing the display bezel to the display assembly.
4. Remove the five screws and loosen the captive screw on the display bezel.
5. Using your fingertips, carefully pry up the inside edge of the display bezel.
6. Remove the display bezel.



1	rubber pads (6)	2	screws (5)
3	captive screw	4	display bezel

Replacing the Display Bezel

1. Follow the procedures in [Before You Begin](#).
2. Align the display bezel over the display assembly, and gently snap into place.
3. Replace the five screws and tighten the captive screw on the display bezel.
4. Replace the six rubber pads to cover the screws securing the display bezel to the display assembly.
5. Replace the display assembly (see [Replacing the Display Assembly](#)).

CAUTION: Before turning on the computer, replace all screws and ensure that no stray screws remain inside the computer. Failure to do so may result in damage to the computer.

Display Panel

Removing the Display Panel

1. Follow the procedures in [Before You Begin](#).
2. Remove the display assembly (see [Removing the Display Assembly](#)).
3. Remove the display bezel (see [Removing the Display Bezel](#)).
4. Remove the two screws that secure the display panel to the display cover.
5. Remove the display panel.

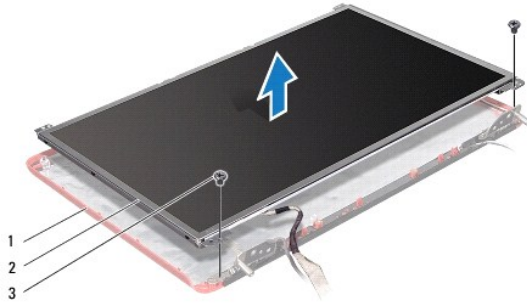

1	display cover	2	display panel
3	screws (2)		

6. Remove the six screws (three on each side) that secure the display panel brackets to the display panel.

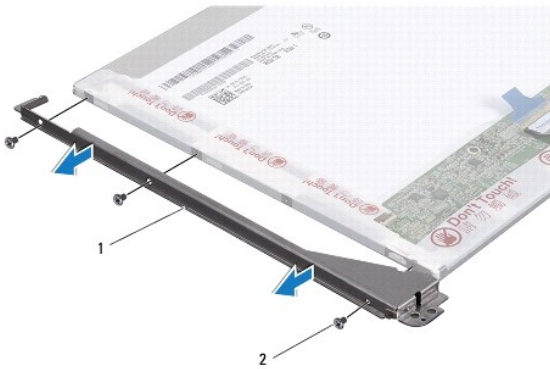

1	display panel brackets (2)	2	screws (6)
---	----------------------------	---	------------

7. Turn the display panel over and remove the display panel cable (see [Removing the Display Panel Cable](#)).

Replacing the Display Panel

1. Follow the procedures in [Before You Begin](#).
2. Replace the display panel cable on the back of the display panel (see [Replacing the Display Panel Cable](#)).
3. Replace the six screws that secure the display panel brackets to the display panel.
4. Align the screw holes on the display panel with the holes on the display cover.
5. Replace the two screws that secure the display panel to the display cover.
6. Replace the display bezel (see [Replacing the Display Bezel](#)).
7. Replace the display assembly (see [Replacing the Display Assembly](#)).

CAUTION: Before turning on the computer, replace all screws and ensure that no stray screws remain inside the computer. Failure to do so may result in damage to the computer.

Display Panel Cable

Removing the Display Panel Cable

1. Follow the procedures in [Before You Begin](#).
2. Remove the display assembly (see [Removing the Display Assembly](#)).
3. Remove the display bezel (see [Removing the Display Bezel](#)).
4. Remove the display panel (see [Removing the Display Panel](#)).
5. Turn the display panel over and place it on a clean surface.
6. Disconnect the display panel cable from the display board connector.

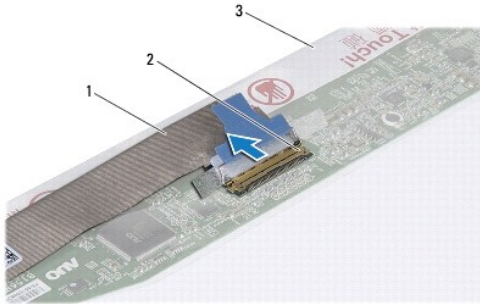

1	display panel cable	2	display board connector
3	back of the display panel		

Replacing the Display Panel Cable

1. Follow the procedures in [Before You Begin](#).
2. Connect the display panel cable to the display board connector.
3. Replace the display panel (see [Replacing the Display Panel](#)).
4. Replace the display bezel (see [Replacing the Display Bezel](#)).
5. Replace the display assembly (see [Replacing the Display Assembly](#)).

CAUTION: Before turning on the computer, replace all screws and ensure that no stray screws remain inside the computer. Failure to do so may result in damage to the computer.

Display Hinges

Removing the Display Hinges

1. Follow the procedures in [Before You Begin](#).
2. Remove the display assembly (see [Removing the Display Assembly](#)).
3. Remove the display bezel (see [Removing the Display Bezel](#)).
4. Remove the display panel (see [Removing the Display Panel](#)).
5. Remove the two screws (one on each hinge) that secure the display hinges to the display cover.
6. Remove the two hinges.

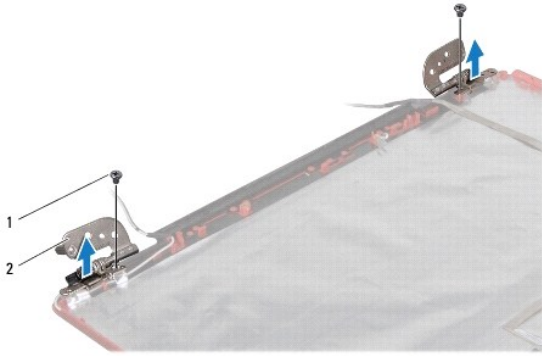

1	screws (2)	2	hinges (2)
---	------------	---	------------

Replacing the Display Hinges

1. Follow the procedures in [Before You Begin](#).
2. Replace the hinges on the display cover.
3. Replace the two screws (one on each hinge) that secure the display hinges to the display cover.
4. Replace the display panel (see [Replacing the Display Panel](#)).
5. Replace the display bezel (see [Replacing the Display Bezel](#)).
6. Replace the display assembly (see [Replacing the Display Assembly](#)).

CAUTION: Before turning on the computer, replace all screws and ensure that no stray screws remain inside the computer. Failure to do so may result in damage to the computer.

[Back to Contents Page](#)

Hard Drive

Dell™ Inspiron™ 1546 Service Manual

- [Removing the Hard Drive](#)
- [Replacing the Hard Drive](#)

- ⚠ **WARNING:** Before working inside your computer, read the safety information that shipped with your computer. For additional safety best practices information, see the Regulatory Compliance Homepage at www.dell.com/regulatory_compliance.
- ⚠ **WARNING:** If you remove the hard drive from the computer when the drive is hot, do not touch the metal housing of the hard drive.
- ⚠ **CAUTION:** Only a certified service technician should perform repairs on your computer. Damage due to servicing that is not authorized by Dell is not covered by your warranty.
- ⚠ **CAUTION:** To prevent data loss, turn off your computer (see [Turning Off Your Computer](#)) before removing the hard drive. Do not remove the hard drive while the computer is On or in Sleep state.
- ⚠ **CAUTION:** To avoid electrostatic discharge, ground yourself by using a wrist grounding strap or by periodically touching an unpainted metal surface (such as a connector on your computer).
- ⚠ **CAUTION:** Hard drives are extremely fragile. Exercise care when handling the hard drive.
- ⚠ **CAUTION:** To help prevent damage to the system board, remove the main battery (see [Removing the Battery](#)) before working inside the computer.
- ⚠ **CAUTION:** When you disconnect a cable, pull on its connector or on its pull-tab, not on the cable itself. Some cables have connectors with locking tabs; if you are disconnecting this type of cable, press in on the locking tabs before you disconnect the cable. As you pull connectors apart, keep them evenly aligned to avoid bending any connector pins. Also, before you connect a cable, ensure that both connectors are correctly oriented and aligned.
- 🔧 **NOTE:** Dell does not guarantee compatibility or provide support for hard drives from sources other than Dell.
- 🔧 **NOTE:** If you are installing a hard drive from a source other than Dell, you need to install an operating system, drivers, and utilities on the new hard drive (see the *Dell Technology Guide*).

Removing the Hard Drive

1. Follow the procedures in [Before You Begin](#).
2. Remove the battery (see [Removing the Battery](#)).

- ⚠ **CAUTION:** When the hard drive is not in the computer, store it in protective antistatic packaging (see "Protecting Against Electrostatic Discharge" in the safety instructions that shipped with your computer).

3. Remove the two screws that secure the hard drive assembly to the computer base.
4. Slide the hard drive assembly out of the hard drive compartment.

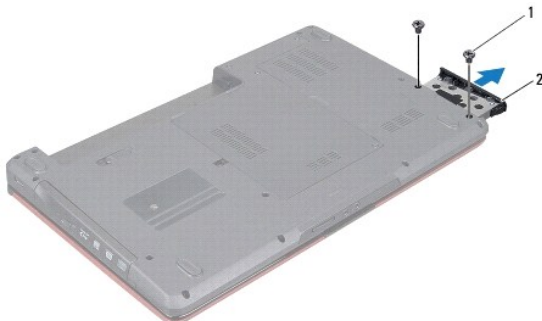

1	screws (2)	2	hard drive assembly
---	------------	---	---------------------

5. Remove the two screws that secure the hard drive bezel to the hard drive.

6. Lift the hard drive bezel off the hard drive.

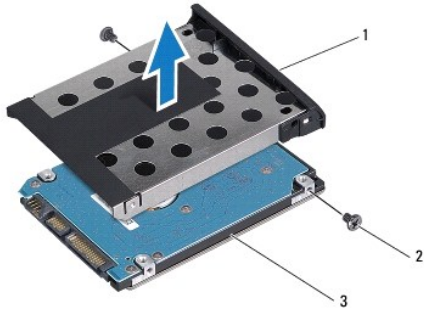

1	hard drive bezel	2	screws (2)
3	hard drive		

Replacing the Hard Drive

1. Follow the procedures in [Before You Begin](#).
2. Remove the new hard drive from its packaging.
Save the original packaging for storing or shipping the hard drive.
3. Align the screw holes on the hard drive bezel with the holes on the hard drive.
4. Replace the two screws that secure the hard drive bezel to the hard drive.
5. Slide the hard drive assembly into the hard drive compartment until it is fully seated.
6. Replace the two screws that secure the hard drive assembly to the computer base.
7. Replace the battery (see [Replacing the Battery](#)).

CAUTION: Before turning on the computer, replace all screws and ensure that no stray screws remain inside the computer. Failure to do so may result in damage to the computer.

8. Install the operating system for your computer, as needed. See "Restoring Your Operating System" in the *Setup Guide*.
9. Install the drivers and utilities for your computer, as needed. For more information, see the *Dell Technology Guide*.

[Back to Contents Page](#)

Keyboard

Dell™ Inspiron™ 1546 Service Manual

- [Removing the Keyboard](#)
- [Replacing the Keyboard](#)

- ⚠ WARNING:** Before working inside your computer, read the safety information that shipped with your computer. For additional safety best practices information, see the Regulatory Compliance Homepage at www.dell.com/regulatory_compliance.
- ⚠ CAUTION:** Only a certified service technician should perform repairs on your computer. Damage due to servicing that is not authorized by Dell™ is not covered by your warranty.
- ⚠ CAUTION:** To avoid electrostatic discharge, ground yourself by using a wrist grounding strap or by periodically touching an unpainted metal surface (such as a connector on your computer).
- ⚠ CAUTION:** To help prevent damage to the system board, remove the main battery (see [Removing the Battery](#)) before working inside the computer.
-

Removing the Keyboard

1. Follow the procedures in [Before You Begin](#).
2. Remove the battery (see [Removing the Battery](#)).
3. Remove the center control cover (see [Removing the Center Control Cover](#)).
4. Remove the two screws that secure the keyboard to the palm rest.

⚠ CAUTION: The keycaps on the keyboard are fragile, easily dislodged, and time-consuming to replace. Be careful when removing and handling the keyboard.

⚠ CAUTION: Be extremely careful when removing and handling the keyboard. Failure to do so could result in scratching the display panel.

5. Ease the keyboard up until the keyboard cable connector is visible.
6. Without pulling hard on the keyboard, hold it towards the display.
7. Lift the connector latch that secures the keyboard cable to the system board connector and remove the cable.
8. Lift the keyboard off the palm rest.

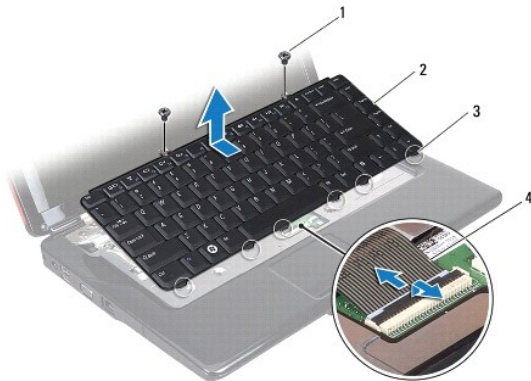

1	screws (2)	2	keyboard
3	tabs (6)	4	keyboard cable

Replacing the Keyboard

1. Follow the procedures in [Before You Begin](#).
2. Slide the keyboard cable into the connector on the system board. Press down on the connector latch to secure the keyboard cable to the system board connector.
3. Align the six tabs on the keyboard with the slots on the palm rest.
4. Place the keyboard on the palm rest.
5. Replace the two screws that secure the keyboard to the palm rest.
6. Replace the center control cover (see [Replacing the Center Control Cover](#)).
7. Replace the battery (see [Replacing the Battery](#)).

 **CAUTION:** Before turning on the computer, replace all screws and ensure that no stray screws remain inside the computer. Failure to do so may result in damage to the computer.

[Back to Contents Page](#)

Battery Latch Assembly

Dell™ Inspiron™ 1546 Service Manual

- [Removing the Battery Latch Assembly](#)
- [Replacing the Battery Latch Assembly](#)

- ⚠ WARNING:** Before working inside your computer, read the safety information that shipped with your computer. For additional safety best practices information, see the Regulatory Compliance Homepage at www.dell.com/regulatory_compliance.
- ⚠ CAUTION:** Only a certified service technician should perform repairs on your computer. Damage due to servicing that is not authorized by Dell™ is not covered by your warranty.
- ⚠ CAUTION:** To avoid electrostatic discharge, ground yourself by using a wrist grounding strap or by periodically touching an unpainted metal surface (such as a connector on your computer).
- ⚠ CAUTION:** To help prevent damage to the system board, remove the main battery (see [Removing the Battery](#)) before working inside the computer.
-

Removing the Battery Latch Assembly

1. Follow the procedures in [Before You Begin](#).
2. Remove the system board (see [Removing the System Board](#)).

⚠ CAUTION: Before you remove the battery release latch, observe the orientation of the latch to ensure proper installation when the button is replaced.

3. Press and push the plastic clips on battery release latch to release it from the battery latch assembly.
4. Using a small screwdriver, remove the latch spring on the battery latch assembly.
5. Slide the battery latch assembly to the side and lift it off the computer base.

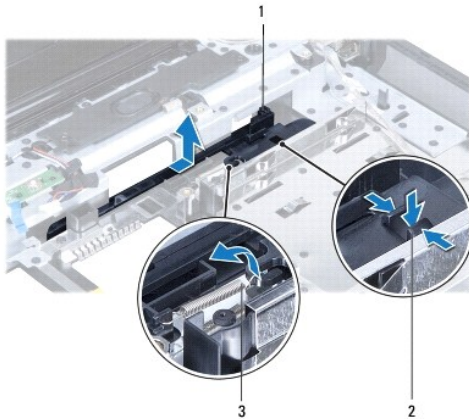

1	battery latch assembly	2	plastic clips
3	latch spring		

Replacing the Battery Latch Assembly

⚠ CAUTION: Ensure the battery latch assembly is properly oriented. The indent for the button should face up when installing the assembly.

1. Follow the procedures in [Before You Begin](#).

2. Slide the battery latch assembly into place.
3. Using a small screwdriver, place the latch spring over the hook on the computer base.
4. Push the plastic clips on the battery release latch into the hole on the battery latch assembly to secure the battery release latch.
5. Replace the system board (see [Replacing the System Board](#)).

 **CAUTION:** Before turning on the computer, replace all screws and ensure that no stray screws remain inside the computer. Failure to do so may result in damage to the computer.

[Back to Contents Page](#)

[Back to Contents Page](#)

Memory Module(s)

Dell™ Inspiron™ 1546 Service Manual

- [Removing the Memory Module\(s\)](#)
- [Replacing the Memory Module\(s\)](#)

- ⚠ WARNING:** Before working inside your computer, read the safety information that shipped with your computer. For additional safety best practices information, see the Regulatory Compliance Homepage at www.dell.com/regulatory_compliance.
- ⚠ CAUTION:** Only a certified service technician should perform repairs on your computer. Damage due to servicing that is not authorized by Dell™ is not covered by your warranty.
- ⚠ CAUTION:** To avoid electrostatic discharge, ground yourself by using a wrist grounding strap or by periodically touching an unpainted metal surface (such as a connector on your computer).
- ⚠ CAUTION:** To help prevent damage to the system board, remove the main battery (see [Removing the Battery](#)) before working inside the computer.

You can increase your computer's memory by installing memory modules on the system board. See "Basic Specifications" in your *Setup Guide* or the *Comprehensive Specifications* at support.dell.com/manuals for information on the type of memory supported by your computer.

📌 NOTE: Memory modules purchased from Dell are covered under your computer warranty.

Your computer has two user-accessible SODIMM sockets that can be accessed from the bottom of the computer.

Removing the Memory Module(s)

1. Follow the procedures in [Before You Begin](#).
2. Remove the battery (see [Removing the Battery](#)).
3. Remove the module cover (see [Removing the Module Cover](#)).

⚠ CAUTION: To prevent damage to the memory module connector, do not use tools to spread the memory module securing clips.

4. Use your fingertips to carefully spread apart the securing clips on each end of the memory module connector until the module pops up.
5. Remove the memory module from the memory module connector.

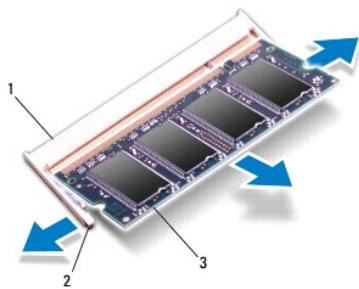

1	memory module connector	2	securing clips (2)
3	memory module		

Replacing the Memory Module(s)

CAUTION: If you need to install memory modules in two connectors, install a memory module in the lower connector before you install a memory module in the upper connector.

1. Follow the procedures in [Before You Begin](#).
2. Align the notch in the memory module with the tab in the memory module connector.
3. Slide the memory module firmly into the slot at a 45-degree angle, and press the memory module down until it clicks into place. If you do not hear the click, remove the memory module and reinstall it.

NOTE: If the memory module is not installed properly, the computer may not boot.

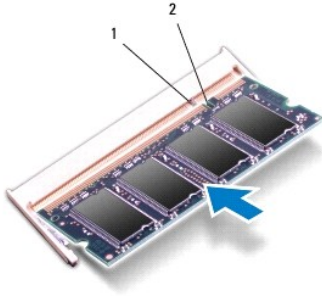

1	tab	2	notch
---	-----	---	-------

4. Replace the module cover (see [Replacing the Module Cover](#)).

CAUTION: Before turning on the computer, replace all screws and ensure that no stray screws remain inside the computer. Failure to do so may result in damage to the computer.

5. Replace the battery (see [Replacing the Battery](#)), or connect the AC adapter to your computer and an electrical outlet.
6. Turn on the computer.

As the computer boots, it detects the memory module(s) and automatically updates the system configuration information.

To confirm the amount of memory installed in the computer:

Windows Vista®:

Click **Start** → **Help and Support** → **Dell System Information**.

Windows 7:

Click the **Start** → **Control Panel** → **System and Security** → **System**.

[Back to Contents Page](#)

Wireless Mini-Card

Dell™ Inspiron™ 1546 Service Manual

- [Removing the Mini-Card](#)
- [Replacing the Mini-Card](#)

- ⚠ WARNING:** Before working inside your computer, read the safety information that shipped with your computer. For additional safety best practices information, see the Regulatory Compliance Homepage at www.dell.com/regulatory_compliance.
- ⚠ CAUTION:** Only a certified service technician should perform repairs on your computer. Damage due to servicing that is not authorized by Dell™ is not covered by your warranty.
- ⚠ CAUTION:** To avoid electrostatic discharge, ground yourself by using a wrist grounding strap or by periodically touching an unpainted metal surface (such as a connector on your computer).
- ⚠ CAUTION:** To help prevent damage to the system board, remove the main battery (see [Removing the Battery](#)) before working inside the computer.
- 🔧 NOTE:** Dell does not guarantee compatibility or provide support for Mini-Cards from sources other than Dell.

If you ordered a wireless Mini-Card with your computer, the card is already installed.

Your computer supports one half Mini-Card slot for Wireless Local Area Network (WLAN).

- 🔧 NOTE:** Depending on the configuration of the computer when it was sold, the Mini-Card slot may or may not have a Mini-Card installed.

Removing the Mini-Card

1. Follow the procedures in [Before You Begin](#).
2. Remove the battery (see [Removing the Battery](#)).
3. Remove the module cover (see [Removing the Module Cover](#)).
4. Disconnect the antenna cables from the Mini-Card.

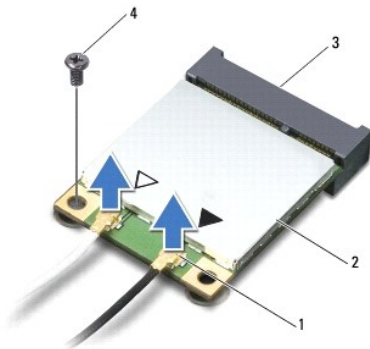

1	antenna cable connectors (2)	2	Mini-Card
3	system board connector	4	screw

5. Remove the screw that secures the Mini-Card to the system board.
6. Lift the Mini-Card out of the system board connector.

- ⚠ CAUTION:** When the Mini-Card is not in the computer, store it in protective antistatic packaging (see "Protecting Against Electrostatic Discharge" in the safety instructions that shipped with your computer).

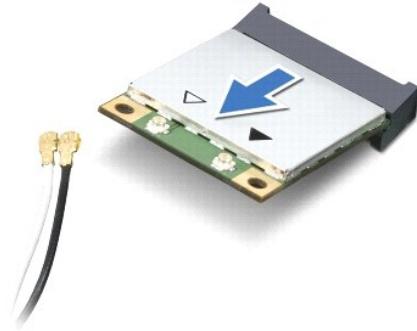

Replacing the Mini-Card

1. Follow the procedures in [Before You Begin](#).
2. Remove the new Mini-Card from its packaging.

⚠ **CAUTION:** Use firm and even pressure to slide the card into place. If you use excessive force, you may damage the connector.

⚠ **CAUTION:** The connectors are keyed to ensure correct insertion. If you feel resistance, check the connectors on the card and on the system board, and realign the card.

⚠ **CAUTION:** To avoid damage to the Mini-Card, never place cables under the card.

3. Insert the Mini-Card at a 45-degree angle into the appropriate system board connector.
4. Press the other end of the Mini-Card down into the slot on the system board and replace the screw that secures the Mini-Card to the system board connector.
5. Connect the appropriate antenna cables to the Mini-Card. The following table provides the antenna cable color scheme for the Mini-Card supported by your computer.

Connectors on the Mini-Card	Antenna Cable Color Scheme
WLAN (2 antenna cables)	
Main WLAN (white triangle)	white
Auxiliary WLAN (black triangle)	black

6. Secure unused antenna cables in the protective mylar sleeve.
7. Replace the module cover (see [Replacing the Module Cover](#)).
8. Replace the battery (see [Replacing the Battery](#)).

⚠ **CAUTION:** Before turning on the computer, replace all screws and ensure that no stray screws remain inside the computer. Failure to do so may result in damage to the computer.

9. Install the drivers and utilities for your computer, as required. For more information, see the *Dell Technology Guide*.

🔧 **NOTE:** If you are installing a communication card from a source other than Dell, you must install the appropriate drivers and utilities. For more generic driver information, see the *Dell Technology Guide*.

Optical Drive

Dell™ Inspiron™ 1546 Service Manual

- [Removing the Optical Drive](#)
- [Replacing the Optical Drive](#)

- ⚠ WARNING:** Before working inside your computer, read the safety information that shipped with your computer. For additional safety best practices information, see the Regulatory Compliance Homepage at www.dell.com/regulatory_compliance.
- ⚠ CAUTION:** Only a certified service technician should perform repairs on your computer. Damage due to servicing that is not authorized by Dell™ is not covered by your warranty.
- ⚠ CAUTION:** To avoid electrostatic discharge, ground yourself by using a wrist grounding strap or by periodically touching an unpainted metal surface (such as a connector on your computer).
- ⚠ CAUTION:** To help prevent damage to the system board, remove the main battery (see [Removing the Battery](#)) before working inside the computer.
-

Removing the Optical Drive

1. Follow the procedures in [Before You Begin](#).
2. Remove the battery (see [Removing the Battery](#)).
3. Remove the screw that secures the optical drive to the computer base.
4. Using a plastic scribe, push the notch to remove the optical drive from the optical drive bay.
5. Slide the optical drive out of the optical drive bay.

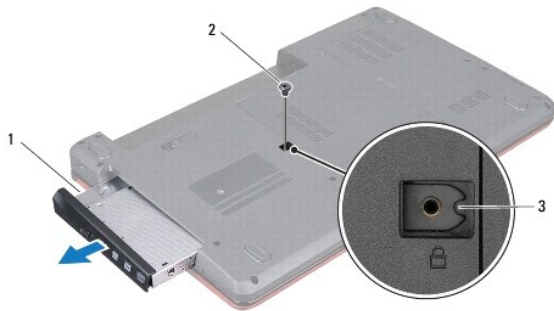

1	optical drive	2	screw
3	notch		

Replacing the Optical Drive

1. Follow the procedures in [Before You Begin](#).
2. Slide the optical drive into the optical drive bay until it is fully seated.
3. Replace the screw that secures the optical drive to the computer base.
4. Replace the battery (see [Replacing the Battery](#)).

- ⚠ CAUTION:** Before turning on the computer, replace all screws and ensure that no stray screws remain inside the computer. Failure to do so may result in damage to the computer.
-

Palm Rest

Dell™ Inspiron™ 1546 Service Manual

- [Removing the Palm Rest](#)
- [Replacing the Palm Rest](#)

- ⚠ WARNING:** Before working inside your computer, read the safety information that shipped with your computer. For additional safety best practices information, see the Regulatory Compliance Homepage at www.dell.com/regulatory_compliance.
- ⚠ CAUTION:** Only a certified service technician should perform repairs on your computer. Damage due to servicing that is not authorized by Dell™ is not covered by your warranty.
- ⚠ CAUTION:** To avoid electrostatic discharge, ground yourself by using a wrist grounding strap or by periodically touching an unpainted metal surface (such as a connector on your computer).
- ⚠ CAUTION:** To help prevent damage to the system board, remove the main battery (see [Removing the Battery](#)) before working inside the computer.
-

Removing the Palm Rest

1. Follow the procedures in [Before You Begin](#).
2. Remove the battery (see [Removing the Battery](#)).
3. Remove the module cover (see [Removing the Module Cover](#)).
4. Remove the memory module(s) (see [Removing the Memory Module\(s\)](#)).
5. Remove the hard drive (see [Removing the Hard Drive](#)).
6. Remove the eleven screws from the computer base.

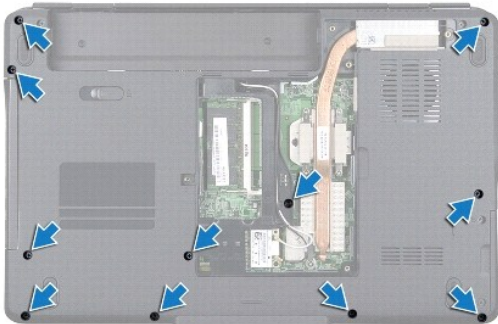

7. Remove the Mini-Card (see [Removing the Mini-Card](#)).
8. Make note of the Mini-Card antenna cables routing and remove the cables from the routing guides.
9. Remove the center control cover (see [Removing the Center Control Cover](#)).
10. Remove the keyboard (see [Removing the Keyboard](#)).
11. Remove the Bluetooth module (see [Internal Module With Bluetooth® Wireless Technology](#)).
12. Disconnect the display cable, camera cable, power button board cable, and touch pad cable from the respective system board connectors.
13. Make note of the Mini-Card antenna cable routing and carefully dislodge the antenna cables from the slot on the computer. Pull the cables away, so that they are clear of the palm rest.

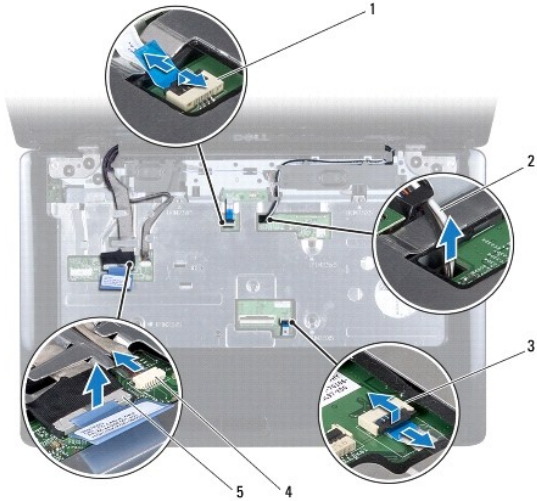

1	power button board cable connector	2	Mini-Card cable routing
3	touch pad cable connector	4	camera cable connector
5	display cable connector		

14. Remove the five screws that secure the palm rest to the system board.

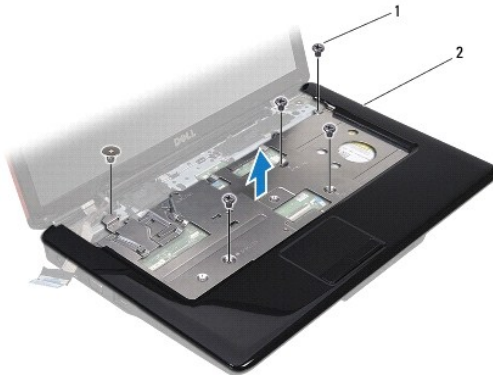

1	screws (5)	2	palm rest
---	------------	---	-----------

CAUTION: Carefully separate the palm rest from the computer base to avoid damage to the palm rest.

15. Starting at the right or left of the palm rest, use your fingers to separate the palm rest from the computer base.

16. Lift the palm rest off the computer base.

Replacing the Palm Rest

1. Follow the procedures in [Before You Begin](#).
2. Align the palm rest on the computer base and gently snap the palm rest into place.
3. Replace the five screws on the palm rest.
4. Connect the display cable, camera cable, power button board cable, and touch pad cable to the respective system board connectors.
5. Route the Mini-Card antenna cables, and guide the cables to the bottom of the computer through the cable routing slot.

6. Replace the Bluetooth module (see [Internal Module With Bluetooth® Wireless Technology](#)).
7. Replace the keyboard (see [Replacing the Keyboard](#)).
8. Replace the center control cover (see [Replacing the Center Control Cover](#)).
9. Replace the eleven screws at the bottom of the computer.
10. Route the Mini-Card antenna cables through the routing guides at the bottom of the computer, and replace the Mini-Card (see [Replacing the Mini-Card](#)).
11. Replace the memory module(s) (see [Replacing the Memory Module\(s\)](#)).
12. Replace the module cover (see [Replacing the Module Cover](#)).
13. Replace the hard drive (see [Replacing the Hard Drive](#)).
14. Replace the battery (see [Replacing the Battery](#)).

 **CAUTION:** Before turning on the computer, replace all screws and ensure that no stray screws remain inside the computer. Failure to do so may result in damage to the computer.

[Back to Contents Page](#)

Power Button Board

Dell™ Inspiron™ 1546 Service Manual

- [Removing the Power Button Board](#)
- [Replacing the Power Button Board](#)

- ⚠ WARNING:** Before working inside your computer, read the safety information that shipped with your computer. For additional safety best practices information, see the Regulatory Compliance Homepage at www.dell.com/regulatory_compliance.
- ⚠ CAUTION:** Only a certified service technician should perform repairs on your computer. Damage due to servicing that is not authorized by Dell™ is not covered by your warranty.
- ⚠ CAUTION:** To avoid electrostatic discharge, ground yourself by using a wrist grounding strap or by periodically touching an unpainted metal surface (such as a connector on your computer).
- ⚠ CAUTION:** To help prevent damage to the system board, remove the main battery (see [Removing the Battery](#)) before working inside the computer.
-

Removing the Power Button Board

1. Follow the procedures in [Before You Begin](#).
2. Remove the battery (see [Removing the Battery](#)).
3. Remove the module cover (see [Removing the Module Cover](#)).
4. Remove the memory module(s) (see [Removing the Memory Module\(s\)](#)).
5. Remove the hard drive (see [Removing the Hard Drive](#)).
6. Remove the center control cover (see [Removing the Center Control Cover](#)).
7. Remove the keyboard (see [Removing the Keyboard](#)).
8. Lift the connector latch to release the power button board cable from the system board connector.

- ⚠ CAUTION:** The power button board is glued to the palm rest. Do not pull on the power button board cable to remove the power button board.

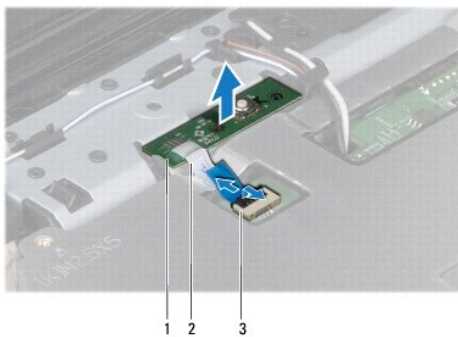

1	power button board	2	power button board cable
3	power button board cable connector		

9. Using a plastic scribe, pry out the power button board to release it from the palm rest.
 10. Lift the power button board off the palm rest.
-

Replacing the Power Button Board

1. Follow the procedures in [Before You Begin](#).
2. Align the holes on the power button board with the guide posts on the palm rest and adhere it in place.
3. Slide the power button board cable into the system board connector and press down the connector latch to secure the cable to the connector.
4. Replace the keyboard (see [Replacing the Keyboard](#)).
5. Replace the center control cover (see [Replacing the Center Control Cover](#)).
6. Replace the hard drive (see [Replacing the Hard Drive](#)).
7. Replace the memory module(s) (see [Replacing the Memory Module\(s\)](#)).
8. Replace the module cover (see [Replacing the Module Cover](#)).
9. Replace the battery (see [Replacing the Battery](#)).

 **CAUTION:** Before turning on the computer, replace all screws and ensure that no stray screws remain inside the computer. Failure to do so may result in damage to the computer.

[Back to Contents Page](#)

Battery

Dell™ Inspiron™ 1546 Service Manual

- [Removing the Battery](#)
- [Replacing the Battery](#)

- ⚠ WARNING:** Before working inside your computer, read the safety information that shipped with your computer. For additional safety best practices information, see the Regulatory Compliance Homepage at www.dell.com/regulatory_compliance.
- ⚠ CAUTION:** Only a certified service technician should perform repairs on your computer. Damage due to servicing that is not authorized by Dell™ is not covered by your warranty.
- ⚠ CAUTION:** To avoid electrostatic discharge, ground yourself by using a wrist grounding strap or by periodically touching an unpainted metal surface (such as a connector on your computer).
- ⚠ CAUTION:** To avoid damage to the computer, use only the battery designed for this particular Dell computer. Do not use batteries designed for other Dell computers.
-

Removing the Battery

1. Follow the procedures in [Before You Begin](#).
2. Turn the computer over.
3. Slide the battery release latch to the unlock position until it clicks into place.
4. Slide the battery out of the battery bay.

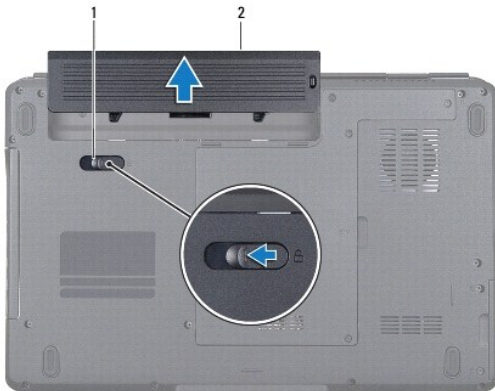

1	battery release latch	2	battery
---	-----------------------	---	---------





Replacing the Battery

1. Follow the procedures in [Before You Begin](#).
 2. Slide the battery into the battery bay until it clicks into place.
-

Speakers

Dell™ Inspiron™ 1546 Service Manual

- [Removing the Speakers](#)
- [Replacing the Speakers](#)

-  **WARNING:** Before working inside your computer, read the safety information that shipped with your computer. For additional safety best practices information, see the Regulatory Compliance Homepage at www.dell.com/regulatory_compliance.
-  **CAUTION:** Only a certified service technician should perform repairs on your computer. Damage due to servicing that is not authorized by Dell™ is not covered by your warranty.
-  **CAUTION:** To avoid electrostatic discharge, ground yourself by using a wrist grounding strap or by periodically touching an unpainted metal surface (such as a connector on your computer).
-  **CAUTION:** To help prevent damage to the system board, remove the main battery (see [Removing the Battery](#)) before working inside the computer.
-

Removing the Speakers

1. Follow the procedures in [Before You Begin](#).
2. Remove the battery (see [Removing the Battery](#)).
3. Remove the module cover (see [Removing the Module Cover](#)).
4. Remove the memory module(s) (see [Removing the Memory Module\(s\)](#)).
5. Remove the hard drive (see [Removing the Hard Drive](#)).
6. Remove the Mini-Card (see [Removing the Mini-Card](#)).
7. Remove the center control cover (see [Removing the Center Control Cover](#)).
8. Remove the keyboard (see [Removing the Keyboard](#)).
9. Remove the Bluetooth card (see [Removing the Bluetooth Card](#)).
10. Disconnect the Bluetooth board cable from the system board connector (see [Removing the Bluetooth Board](#)).
11. Remove the palm rest (see [Removing the Palm Rest](#)).
12. Remove the four screws (two on each speaker) that secure the speakers to the computer base.
13. Disconnect the speaker cable from the system board connector.
14. Remove the speaker cable from the routing guide.
15. Lift the speakers off the computer base.

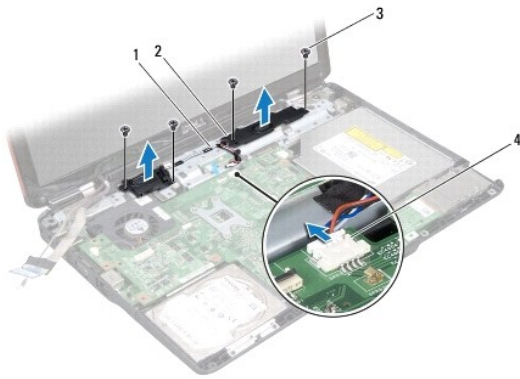

1	speaker cable routing guide	2	speakers (2)
3	screws (4)	4	speaker cable connector

Replacing the Speakers

1. Follow the procedures in [Before You Begin](#).
2. Place the speakers on the computer base.
3. Replace the four screws (two on each speaker) that secure the speakers to the computer base.
4. Route the speaker cable through the routing guide.
5. Connect the speaker cable to the system board connector.
6. Replace the palm rest (see [Replacing the Palm Rest](#)).
7. Connect the Bluetooth board cable to the system board connector (see [Replacing the Bluetooth Board](#)).
8. Replace the Bluetooth card (see [Replacing the Bluetooth Card](#)).
9. Replace the keyboard (see [Replacing the Keyboard](#)).
10. Replace the center control cover (see [Replacing the Center Control Cover](#)).
11. Replace the Mini-Card (see [Replacing the Mini-Card](#)).
12. Replace the memory module(s) (see [Replacing the Memory Module\(s\)](#)).
13. Replace the module cover (see [Replacing the Module Cover](#)).
14. Replace the hard drive (see [Replacing the Hard Drive](#)).
15. Replace the battery (see [Replacing the Battery](#)).

⚠ CAUTION: Before turning on the computer, replace all screws and ensure that no stray screws remain inside the computer. Failure to do so may result in damage to the computer.

[Back to Contents Page](#)

System Board

Dell™ Inspiron™ 1546 Service Manual

- [Removing the System Board](#)
- [Replacing the System Board](#)
- [Entering the Service Tag in the BIOS](#)

⚠ WARNING: Before working inside your computer, read the safety information that shipped with your computer. For additional safety best practices information, see the Regulatory Compliance Homepage at www.dell.com/regulatory_compliance.

⚠ CAUTION: Only a certified service technician should perform repairs on your computer. Damage due to servicing that is not authorized by Dell™ is not covered by your warranty.

⚠ CAUTION: To avoid electrostatic discharge, ground yourself by using a wrist grounding strap or by periodically touching an unpainted metal surface (such as a connector on your computer).

⚠ CAUTION: To help prevent damage to the system board, remove the main battery (see [Removing the Battery](#)) before working inside the computer.

Removing the System Board

1. Follow the procedures in [Before You Begin](#).
2. Remove the battery (see [Removing the Battery](#)).
3. Remove the module cover (see [Removing the Module Cover](#)).
4. Remove the memory module(s) (see [Removing the Memory Module\(s\)](#)).
5. Remove the hard drive (see [Removing the Hard Drive](#)).
6. Remove the optical drive (see [Removing the Optical Drive](#)).
7. Remove the Mini-Card (see [Removing the Mini-Card](#)).
8. Remove the center control cover (see [Removing the Center Control Cover](#)).
9. Remove the keyboard (see [Removing the Keyboard](#)).
10. Remove the Bluetooth module (see [Internal Module With Bluetooth® Wireless Technology](#)).
11. Remove the palm rest (see [Removing the Palm Rest](#)).
12. Remove the daughter board (see [Removing the Daughter Board](#)).
13. Remove the audio connector cover (see [Removing the Audio Connector Cover](#)).
14. Remove the four screws that secure the system board to the computer base.
15. Disconnect the thermal fan cable, speaker cable, and USB module cable from the respective system board connectors.

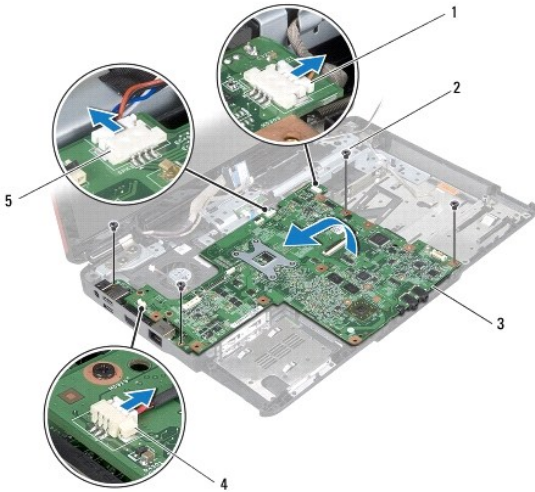

1	USB module cable connector	2	screws (4)
3	system board	4	thermal fan cable connector
5	speaker cable connector		

16. Lift the system board out of the computer base.
17. Turn the system board over.
18. Remove the coin-cell battery (see [Removing the Coin-Cell Battery](#)).

Replacing the System Board

1. Follow the procedures in [Before You Begin](#).
2. Replace the coin-cell battery (see [Replacing the Coin-Cell Battery](#)).
3. Turn the system board over.
4. Align the screw holes on the system board with the screw holes on the computer base.
5. Replace the four screws that secure the system board to the computer base.
6. Replace the audio connector cover (see [Replacing the Audio Connector Cover](#)).
7. Connect the thermal fan cable, speaker cable, and the USB module cable to the respective system board connectors.
8. Replace the daughter board (see [Replacing the Daughter Board](#)).
9. Replace the palm rest (see [Replacing the Palm Rest](#)).
10. Replace the Bluetooth module (see [Internal Module With Bluetooth® Wireless Technology](#)).
11. Replace the keyboard (see [Replacing the Keyboard](#)).
12. Replace the center control cover (see [Replacing the Center Control Cover](#)).
13. Replace the Mini-Card (see [Replacing the Mini-Card](#)).
14. Replace the memory module(s) (see [Replacing the Memory Module\(s\)](#)).
15. Replace the module cover (see [Replacing the Module Cover](#)).
16. Replace the optical drive (see [Replacing the Optical Drive](#)).

17. Replace the hard drive (see [Replacing the Hard Drive](#)).

18. Replace the battery (see [Replacing the Battery](#)).

 **CAUTION:** Before turning on the computer, replace all screws and ensure that no stray screws remain inside the computer. Failure to do so may result in damage to the computer.

19. Turn on the computer.

 **NOTE:** After you have replaced the system board, enter the computer's Service Tag into the BIOS of the replacement system board.

20. Enter the service tag (see [Entering the Service Tag in the BIOS](#)).

Entering the Service Tag in the BIOS

1. Ensure that the AC adapter is plugged in and that the main battery is installed properly.
 2. Turn on the computer.
 3. Press <F2> during POST to enter the system setup program.
 4. Navigate to the security tab and enter the service tag in the **Set Service Tag** field.
-

[Back to Contents Page](#)

Thermal Fan

Dell™ Inspiron™ 1546 Service Manual

- [Removing the Thermal Fan](#)
- [Replacing the Thermal Fan](#)

- ⚠ WARNING:** Before working inside your computer, read the safety information that shipped with your computer. For additional safety best practices information, see the Regulatory Compliance Homepage at www.dell.com/regulatory_compliance.
- ⚠ CAUTION:** Only a certified service technician should perform repairs on your computer. Damage due to servicing that is not authorized by Dell™ is not covered by your warranty.
- ⚠ CAUTION:** To avoid electrostatic discharge, ground yourself by using a wrist grounding strap or by periodically touching an unpainted metal surface (such as a connector on your computer).
- ⚠ CAUTION:** To help prevent damage to the system board, remove the main battery (see [Removing the Battery](#)) before working inside the computer.
-

Removing the Thermal Fan

1. Follow the procedures in [Before You Begin](#).
2. Remove the system board (see [Removing the System Board](#)).
3. Remove the two screws that secure the thermal fan to the computer base.
4. Lift the thermal fan off the computer base.

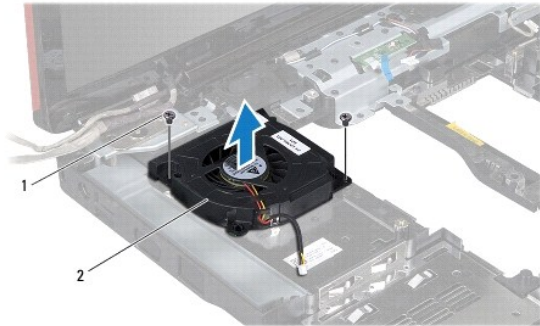

1	screws (2)	2	thermal fan
---	------------	---	-------------

Replacing the Thermal Fan

1. Follow the procedures in [Before You Begin](#).
2. Replace the two screws that secure the thermal fan to the computer base.
3. Replace the system board (see [Replacing the System Board](#)).

- ⚠ CAUTION:** Before turning on the computer, replace all screws and ensure that no stray screws remain inside the computer. Failure to do so may result in damage to the computer.
-